

## POWER QUALITY ANALYZER PW3198

Power Measuring Instruments



*Record and Analyze Power Supply Problems Simultaneously with a Single Unit*

*The New World Standard for Power Quality Analysis*

### ■ Never Miss **the Moment**

- Detect power supply problems and perform onsite troubleshooting
- Do preventive maintenance to avert accidents by managing the power quality

### ■ **CAT IV-600V Safety Standard**

- Meets the CAT IV safety rating required to check an incoming power line
- Safe enough to measure up to 6,000Vpeak of transient overvoltage

### ■ **Easy Setup Function with PRESETS**

- Just select the measurement course, wiring, and clamps
- Automatic one-step setup based on measurement conditions

### ■ **Compliant with New International Standards**

- International power quality measurement standard IEC 61000-4-30 Edition 2 Class A
- High precision with a basic voltage measurement accuracy of 0.1%



ISO 9001  
JMI-0216



ISO 14001  
JQA-E-90091



[www.hioki.com](http://www.hioki.com)

HIOKI company overview, new products, environmental considerations and other information are available on our website.

# One Single Unit Can Solve All Your Power Supply Problems



The number of power supply problems is increasing as power systems are becoming more and more complicated - all due to the rising use of power electronics devices plus a growing installed base of large systems and distributed power supplies. The quickest way to approach these problems is to understand the situation quickly and accurately. The PW3198 Power Quality Analyzer is ready to effectively solve your power supply problems.

## Troubleshooting

- ✓ Understand the actual power situation at the site where the problem is occurring (e.g., the equipment malfunction, failure, reset, overheating, or burning damage).
- ✓ Ideal for troubleshooting solar and wind power generation systems, EV charge stations, smart grids, tooling machines, OA equipment (e.g., computers, printers, and UPS), medical equipment, server rooms, and electrical equipment (e.g., transformers and phase-advancing capacitors).

## Field Survey and Preventive Maintenance

- ✓ Perform long-term measurements of the power quality and study problems that are difficult to detect or that occur intermittently.
- ✓ Maintain electrical equipment and check the operation of solar and wind power generation systems.
- ✓ Manage the parameters with a control set point, such as a voltage fluctuation, flicker, and harmonic voltage.

## Power (Load) Survey

- ✓ Study the power consumption and confirm system capacity before adding load.



# Advanced Features for Safe, Simple, and Accurate Measurements

## 1 International Standard IEC61000-4-30 Edition 2 Class A

Class A is defined in the international standard IEC61000-4-30, which specifies compatibility with power quality parameters, accuracy, and standards to enable comparison and discussion of the measurement results of different measuring instruments. The PW3198 is compliant with the latest IEC61000-4-30 Edition 2 Class A standard. The instrument can perform measurements in accordance with the standard, including continuous gapless calculation, methods to detect events such as dip, swell, and instantaneous power failure, and time synchronization using the optional GPS box.

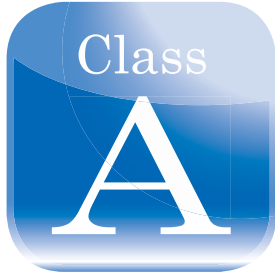

## 2 CAT IV-600V Safety

The PW3198 is compliant with the measurement category CAT IV - 600V and can also safely test the incoming lines for both single-phase and three-phase power supplies.



## 3 Easy to set up - Just select the measurement course and the PW3198 will do the rest

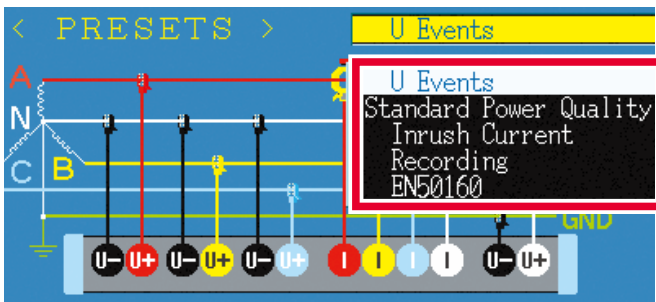

Simply choose the course based on the measurement objective and the necessary configurations will be set automatically.

<b>U Events</b>	Record voltage and frequency and detect errors simultaneously.
<b>Standard Power Quality</b>	Record voltage, current, frequency, and harmonic, and detect errors simultaneously.
<b>Inrush current</b>	Measure the inrush current.
<b>Recording</b>	Record only the TIME PLOT Data but do not detect errors.
<b>EN50160</b>	Perform measurements in accordance with EN50160.

## 4 Highly Accurate, Broadband, Wide Dynamic Range Makes for Reliable Measurements

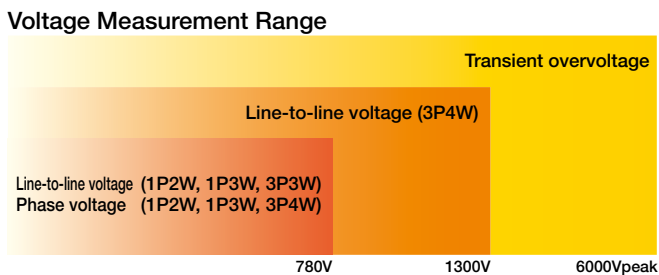

Both low and high voltages can be measured in a single range.

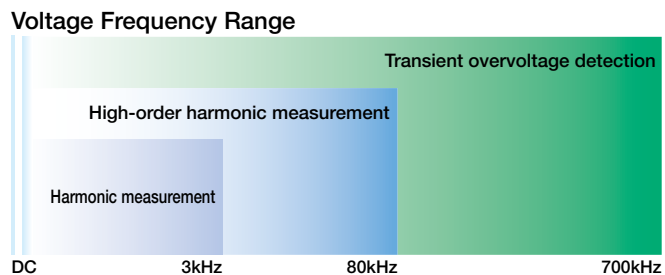

Wide range from DC voltage to 700 kHz

### Basic Measurement Accuracy (50/60 Hz)

<b>Voltage</b>	±0.1% of nominal voltage
<b>Current</b>	±0.2% rdg. ±0.1% f.s. + Clamp-on sensor accuracy
<b>Power</b>	±0.2% rdg. ±0.1% f.s. + Clamp-on sensor accuracy

World's highest level of basic measurement accuracy. Extremely accurate voltage measurement without the need to switch ranges.

### Transient Overvoltage

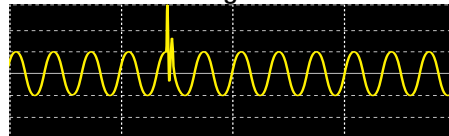

Waveform example

Transient overvoltage can also be measured in a range between the maximum 6,000 V and minimum 1 μs (2 MS/s).

### High-order Harmonic

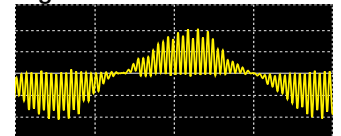

Waveform example

The PW3198 is the first power quality analyzer that can measure the high-order harmonic component of up to 80 kHz.

# PW3198 Never Misses the Moment a Power Supply Failure Occurs

The PW3198 can measure all waveforms of power, harmonic, and error events simultaneously. When a problem occurs with the equipment or system on your site, the PW3198 will help you detect the cause of the problem early and solve it quickly. You can depend on the PW3198 to monitor all aspects of your power supplies.

## Measure All Parameters at the Same Time

### Acquire the Information You Need Quickly by Switching Pages (RMS Value)

Just connect to the measurement line, and the PW3198 will simultaneously measure all parameters, such as power and harmonic. You can then switch pages to view the needed information immediately.

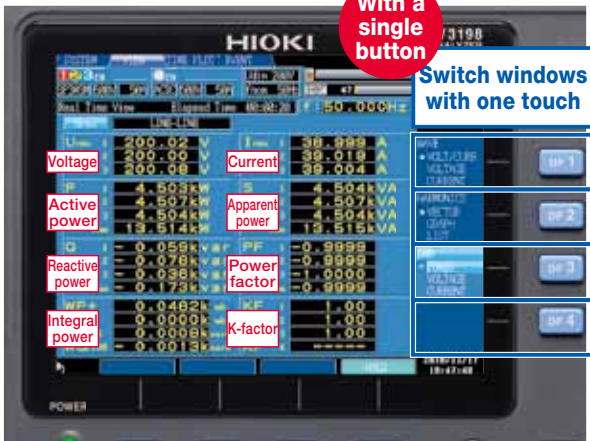

#### DMM Display

Display parameters such as voltage, current, power, power factor, and integral power in a single window.

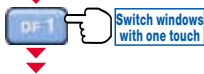

#### Waveform Display

Display the voltage and current waveforms on channels 1 to 4 one above the other in a single window.



#### Vector Display

Display the measured value and vector of the voltage and current of each order harmonic.

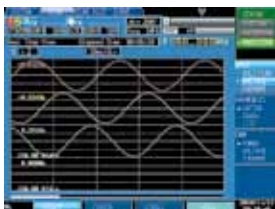

#### 4-channel Waveform Display

Display the voltage and current waveforms on channels 1 to 4 individually.



#### Harmonic Bar Graph Display

Display the RMS value and phase angle of harmonics from the 0th order to the 50th either in a graph or as numerical values.

### Reliably Detect Power Supply Failures (Event)

To detect power supply failures, measurement does not need to be performed multiple times under different conditions. The PW3198 can always monitor and reliably detect all power supply failures for which detection is enabled.

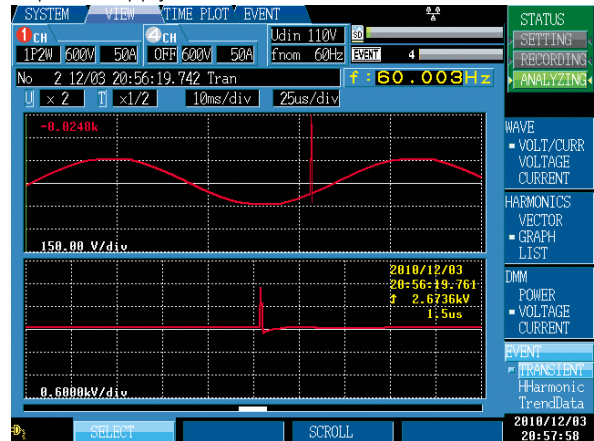

#### Transient Overvoltage (Impulse)

A transient overvoltage is generated by a lightning strike or a contact fault or closed contact of a circuit breaker and relay, and often causes a steep voltage change and a high voltage peak.

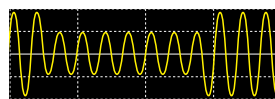

#### Voltage Dip (Voltage Drop)

Voltage drops for a short time as a result of large inrush current generated in the load by, for example, a starting motor.

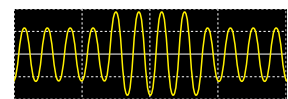

#### Voltage Swell (Voltage Rise)

A voltage swell is generated by a lightning strike or a heavily loaded power line being opened or closed, causing the voltage to rise instantaneously.

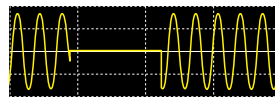

#### Interruption

The power supply stops instantaneously or for a short or long time because electrical power transmission is stopped as a result of a lightning strike, or because the circuit breaker is tripped by a power supply short circuit.

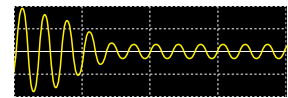

#### Inrush Current

A large current flows instantaneously at the moment electrical equipment, a motor, or similar devices are powered on.

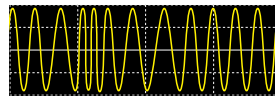

#### Frequency Fluctuations

An excessive increase or decrease of the load causes the operation of a generator to become unstable, resulting in frequency fluctuations.

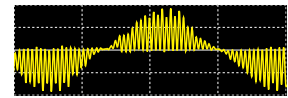

#### High-order Harmonic

Voltage and current waveforms are distorted by noise components generated by a semiconductor control device or the like installed in the power supply of electronic equipment.

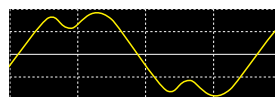

#### Harmonic

Harmonic is generated by a semiconductor control device installed in the power supply of equipment, causing distortion of voltage and current waveforms.

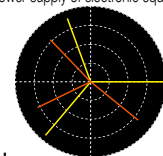

#### Unbalance

An increase or decrease in the load connected to each phase of the three-phase power supply or an unbalanced operation of equipment and devices causes the load of a particular phase to become heavy so that voltage and current waveforms are distorted, voltage drops, or negative phase sequence voltage is generated.

# Simultaneous Recording of **TIME PLOT Data** and **Event Waveforms**

## TIME PLOT Data

## TIME PLOT Recording of All Parameters

The PW3198 can simultaneously record 8,000 or more parameters, such as voltage, current, power, power factor, frequency, integral power, harmonic, and flicker, at the specified recording interval. The PW3198 never fails to capture the peak because it performs calculations continuously and records the maximum, minimum, and average values within the recording interval.

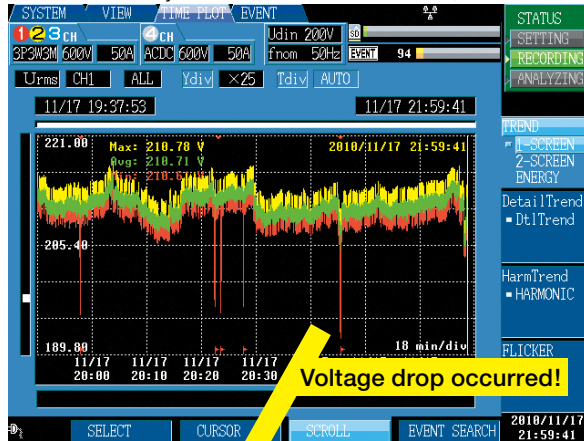

Trend Recording (TIME PLOT Recording)

EVENT Switch windows with one touch

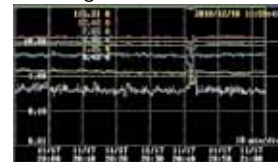

Harmonic Recording

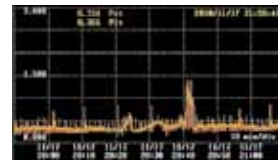

Flicker and ΔV10 Recording

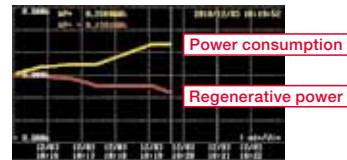

Integral Power Recording

## Event Waveforms

## Capture up to 55,000 Instantaneous Waveforms of Power Supply Failures

The PW3198 can record up to 1,000 instantaneous waveforms of power supply failures (up to 55,000 when repeat recording is set to ON) while performing TIME PLOT recording.

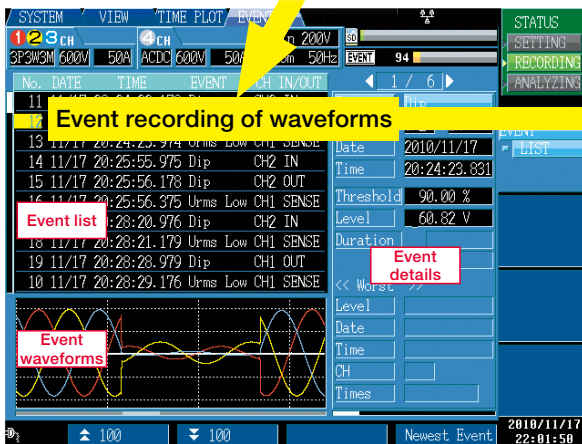

Event List

This list records instantaneous waveforms of power supply failures (events), such as a voltage drop or inrush current, along with the time or other information. Events are always monitored, regardless of the recording interval of the TIME PLOT recording.

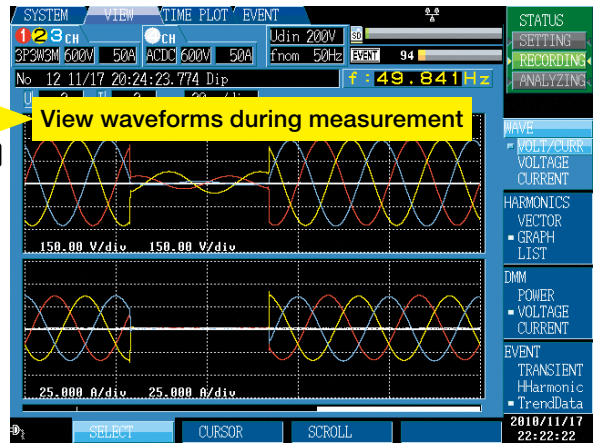

Event Waveform

The PW3198 lets you view the instantaneous waveform (200 ms) of a power supply failure in the window.

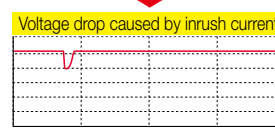
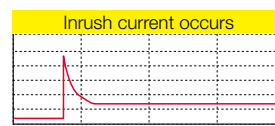

30 seconds

### RMS value changes over 30 seconds

When a voltage drop or inrush current occurs, RMS value changes are recorded over 30 seconds simultaneously. This function can also be used to check the voltage drop caused by inrush current generated by the start of the motor.



## Analyze Recorded Data with a PC Using Application Software 9624-50 PQA-HiVIEW PRO

Use Model 9624-50 PQA-HiVIEW PRO (version 2.00 or later) with a PC to analyze the data collected by the PW3198.

### Viewer Function

Display and analyze the data recorded by the PW3198 POWER QUALITY ANALYZER.

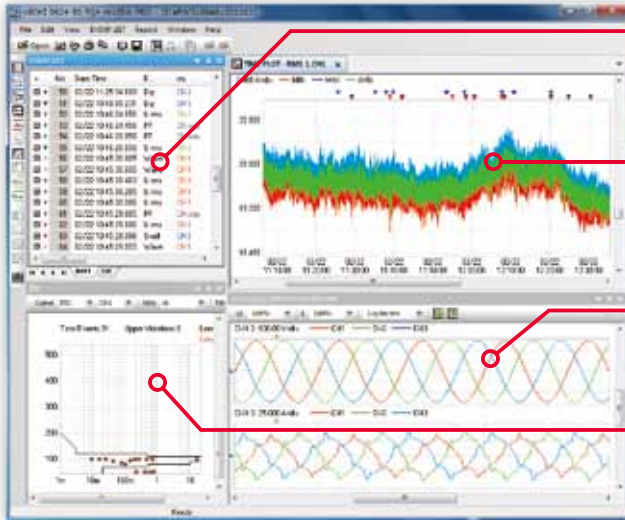

#### Event List Window

Display a list of power supply failures (events) that occurred.

#### TIME PLOT Window

Display the TIME PLOT (recorded trend) data as well as changes in the voltage/current RMS values, harmonic, and many other parameters.

#### Event Waveform Window

Display the waveform of an event that occurred, plus the vector, harmonic, DMM, and instantaneous harmonic values.

#### ITIC Curve Display Window

Analyze the ITIC (CBEMA) curve (tolerance curve) used in the power quality standards in the United States.



Status Window

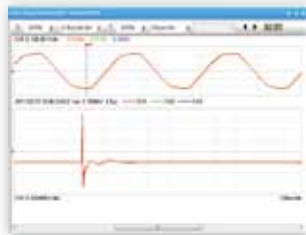

Transient Waveform Window

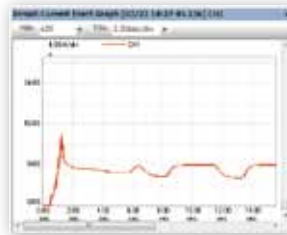

Inrush Current Event Graph Window



Harmonics TIME PLOT Window

### Report Creation Function

Automatically and effortlessly create rich reports for compliance and record management.

Report output items: Voltage/current RMS value fluctuation graph, harmonic fluctuation graph, inter-harmonics fluctuation graph, flicker graph, integral power graph, demand graph, total harmonic voltage/current distortion rate list, EN50160 window (Overview, Harmonic, Measurement Results Category), worst case, transient waveform, maximum/minimum value list, all event waveforms/detailed list, and setup list

#### Print Examples



RMS Value Voltage Fluctuations



All Event Detailed List



TIME PLOT Recording of Parameters



EN50160

### Other Functions

#### CSV Conversion of Measurement Data

Convert data in the range specified in the TIME PLOT window into CSV format and then save for further processing. The 9624-50 can also convert event waveforms into CSV format. Open CSV data using any commercially available spreadsheet software for advanced data management and analysis.

#### Even Analyze Data Recorded with Models 3196 and 3197 PQAs

Data recorded with the HIOKI 3196 and 3197 Power Quality Analyzers can also be analyzed.



#### Download Measurement Data via USB/LAN

Data in the SD card inserted in the PW3198 can be downloaded to a PC via USB or LAN.

#### EN50160 Display Function

EN50160 is a power quality standard for the EU. In this mode, evaluate and analyze power quality in accordance with the standard. You can display the Overview, Harmonic, and Measurement Results Category windows.

#### 9624-50 Specifications

Delivery media	CD-R
Operating environment	AT-compatible PC
OS	Windows XP, Windows Vista (32-bit), Windows 7 (32/64-bit)
Memory	512 MB or more

# Useful Functions for a Wide Variety of Applications

## Large Capacity Recording with SD Card

Data is recorded to a large capacity SD card. The data can be transferred to a PC and analyzed using dedicated application software. If your PC is not equipped with an SD card slot, simply connect a USB cable between the PW3198 and the PC. The PC will then recognize the SD card as removable media.



Repeat record	Recording period
OFF	<b>Max. 35 days</b> Reference value: ALL DATA (all items recorded), repeat recording OFF, and TIME PLOT interval 1 minute or longer
ON	<b>Max. 55 weeks (about 1 year)</b> Reference value: ALL DATA (all items recorded), repeat recording ON (1 week x 55 times), and TIME PLOT interval 10 minutes or longer

## Remote Measurement Using HTTP Server Function

You can use any Internet browser to remotely operate the PW3198, plus download the data stored in the SD card using dedicated software (LAN access required).



Conduct off-site remote control with a tablet PC using a wireless LAN router

## GPS Time Synchronization

The PW9005 GPS BOX lets you synchronize the clock on the PW3198 to the UTC standard time. Eliminate time differences between multiple PQAs and correctly analyze measurement data taken by several instruments.

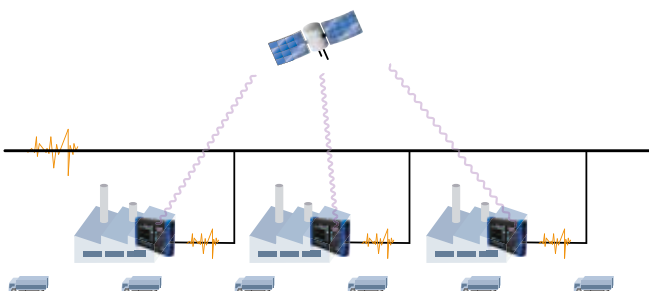

## Simultaneously Measure Three-phase Lines and Grounding Wire

Apart from the main measurement line, you can also measure the AC/DC voltage on another line using Channel 4.



### Yes! Simultaneously!

- Measure the primary and secondary sides of UPS
- Two-line voltage analysis
- Measure three-phase lines and grounding wire
- Measure neutral lines to detect short circuits
- Measure the input and output of a DC-AC converter for solar power generation



## An Assortment of Clamp-on Sensors Covers a Broad Range of Measurements

In addition to current sensors for measuring 100A AC, 500A AC, 1000A AC and 5000A AC rated currents, a 5A AC sensor is also available. In addition, HIOKI's CLAMP ON LEAK SENSORS enable you to accurately measure for leakage current down to the mA level, while the new CT969X-90 AC/DC Clamp On Sensors further widen applications by supporting DC current testing.



## Backup and Recovery from Power Failure

The PW3198 uses the new large capacity BATTERY PACK Z1003, enabling continuous measurement for three hours even if a power failure occurs. In addition, a power failure processing function restarts measurement automatically even if the power is cut off completely during measurement.

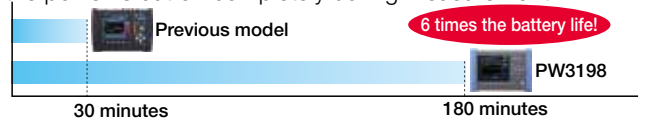

## Other Measurement Applications

- Flicker measurement**  
Measure flicker in conformance with IEC 61000-4-15 Ed2.
- Phase voltage check for Δ connection**  
Use the Δ-Y and Y-Δ conversion function to measure phase voltage using a virtual neutral point.
- 400 Hz line measurement**  
Measure at a power line frequency of 50/60 Hz as well as 400 Hz.

# Power Quality Survey Applications

## The power supply of the office equipment sometimes shuts down

### Survey Objective

The power supply of a printer at the office shuts down even though it is not operated. Equipment other than the printer can also sometimes perform a reset unexpectedly.

### Measurement Method

Setup is very easy. Just install the PW3198 on the site, and measure the voltage, current, and power. To troubleshoot, just select the clamp-on sensor and wiring, and then select the "U Events" course.

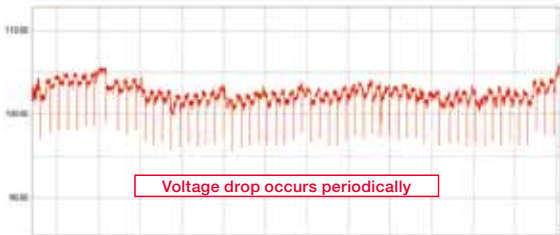

Voltage Fluctuation Graph

### Analysis Report

No failure occurred during the measurement period, but a periodic voltage drop was confirmed. The voltage drop may have been caused by the periodic start and operation of the electrical equipment connected to the power supply line. **Equipment, such as a laser printer, copier, and electrical heater, may start themselves periodically due to residual heat. An instantaneous voltage drop is likely to have been caused by inrush current from equipment that consumes a large amount of power.**

## Medical equipment malfunctions

### Survey Objective

Replacing the equipment with a new one by the service provider did not improve the malfunction. A survey of the power supply was required to clarify the cause.

### Measurement Method

Select the "U Events" course in the PW3198 in the same way as with the office equipment example.

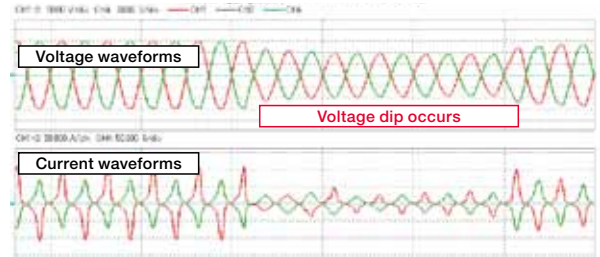

Voltage and Current Waveforms at the Time Voltage Dip Occurs

### Analysis Report

It was determined that a voltage dip (voltage drop) occurred and impacted the operation of the equipment. **If a voltage dip occurs every day on a regular basis, the probable cause is the start of a large air-conditioning unit, pump, heater, or similar equipment.**

## Surveying a Solar Power Generation System

### Survey Objective

- Maintain a solar power generation system and check its operation (verify the power quality)
- Troubleshoot (impact on the peripheral equipment, operation shutdown, etc.)

### Measurement Method

Set up the PW3198 on the site and measure the voltage, current, and power. To survey the power quality, select the "Standard power quality measurement" course in the PRESETS menu. To measure the DC voltage, connect channel 4 to the primary side of the solar panel.

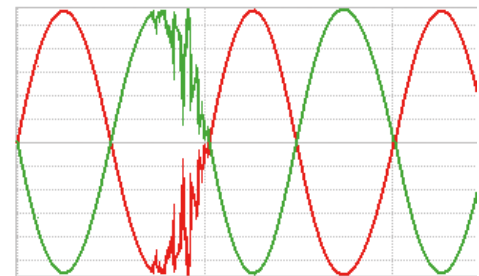

Example of Voltage Waveforms at the Time of Line Switching

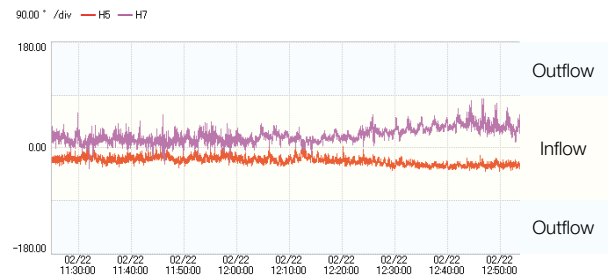

Example of Determining Inflow or Outflow (Inflow of 5th and 7th Order Harmonic)

### Analysis Report

- All parameters can be recorded simultaneously with a single measurement.
- Identify changes in the output voltage of the power conditioner
- Presence or absence of the occurrence of a transient overvoltage
- Frequency fluctuation important for system interconnection
- Identify changes in the harmonic voltage and current included in the output
- Power (AC), integral power (AC), etc.

### Connection Example

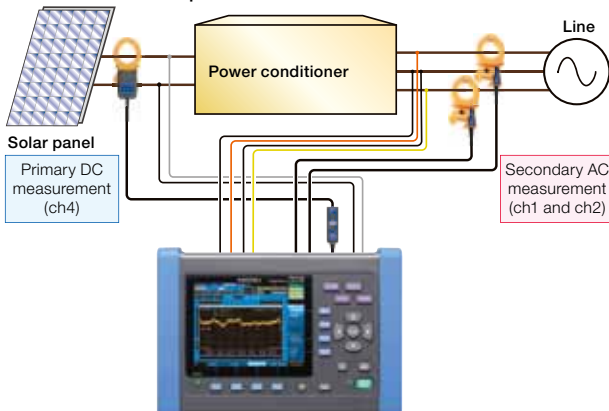



**PW3198 Specifications**(Accuracy guaranteed for one year)**Measurement items**

<b>Voltage</b> measurement items (TIME PLOT Recording)	RMS voltage Frequency DC voltage Harmonic voltage (0 to 50th order) Inter-harmonic voltage (0.5 to 49.5th) Total harmonic voltage distortion factor	Waveform voltage peak Frequency (1 cycle, 10-sec) IEC Flicker (Pst, Plt) Harmonic voltage phase angle (0 to 50th) High order harmonic voltage component Voltage Unbalance factor (Zero-phase /Negative-phase)
<b>Current</b> measurement items (TIME PLOT Recording)	RMS current Waveform current peak Harmonic current phase angle (0 to 50th) Harmonic current (0 to 50th) Inter-harmonic current (0.5 to 49.5th)	High order harmonic current component Total harmonic current distortion factor Current Unbalance factor (Zero-phase /Negative-phase) K factor DC current (when using compatible sensor)
<b>Power</b> measurement items (TIME PLOT Recording)	Active power Reactive power Apparent power Power factor	Harmonic power (0 to 50th) Harmonic voltage-current phase angle (0 to 50th) Active energy Reactive energy
<b>EVENT</b> measurement items (EVENT Recording)	Transient overvoltage Voltage swell Voltage dip Interruption Inrush current	Frequency fluctuations Voltage waveform comparison Timer External events
Event detection using upper and lower thresholds available with other voltage, current and power measurement parameters (excluding Integrated power, Unbalance, Inter-harmonic, Harmonic phase angle, IEC Flicker)		

**Input specifications**

Measurement circuits	Single-phase 2-wire (1P2W), single-phase 3-wire (1P3W), three-phase 3-wire (3P3W2M, 3P4W2.5E) or three-phase 4-wire (3P4W) plus one extra input channel (must be synchronized to reference channel during AC/DC measurement)																																																																	
Fundamental frequency of measurement circuit	50Hz, 60Hz, 400Hz																																																																	
Input channels	Voltage : 4 channels (U1 to U4), Current : 4 channels (I1 to I4)																																																																	
Input methods	Voltage : Isolated and differential inputs (channels not isolated between U1, U2 and U3; channels isolated between U1 to U3 and U4) Current : Insulated clamp-on sensors (voltage output)																																																																	
Input resistance	Voltage : 4M $\Omega$ $\pm$ 80k $\Omega$ (differential inputs) Current : 100k $\Omega$ $\pm$ 10k $\Omega$																																																																	
Compatible clamp sensors	Units with f.s.=0.5V output at rated current input (f.s.=0.5V recommended) Units with rate of 0.1mV/A, 1mV/A, 10mV/A, or 100mV/A																																																																	
Measurement ranges (Ch1 to Ch4 can be configured the same way; only CH4 can be configured separately)	<p>Voltage measurement ranges</p> <table border="1"> <thead> <tr> <th>Voltage measurement items</th> <th>Ranges</th> </tr> </thead> <tbody> <tr> <td>Voltage measurement</td> <td>600.00V</td> </tr> <tr> <td>Transient measurement</td> <td>6.0000kV peak</td> </tr> </tbody> </table> <p>PW3198 current ranges</p> <table border="1"> <thead> <tr> <th>Current sensor</th> <th>Current range setting (A)</th> </tr> </thead> <tbody> <tr><td>9660</td><td>100.00 / 50.000</td></tr> <tr><td>9661</td><td>500.00 / 50.000</td></tr> <tr><td>9667 (500A) *Discontinued</td><td>500.00 / 50.000</td></tr> <tr><td>9667 (5kA) *Discontinued</td><td>5.0000k / 500.00</td></tr> <tr><td>CT9667 (500A)</td><td>500.00 / 50.000</td></tr> <tr><td>CT9667 (5kA)</td><td>5.0000k / 500.00</td></tr> <tr><td>9669</td><td>1.0000k / 100.00</td></tr> <tr><td>9694</td><td>50.000 / 5.0000</td></tr> <tr><td>9695-02</td><td>50.000 / 5.0000</td></tr> <tr><td>9695-03</td><td>100.00 / 10.000</td></tr> </tbody> </table> <table border="1"> <thead> <tr> <th>Current sensor</th> <th>Current range setting(A)</th> </tr> </thead> <tbody> <tr><td>CT9691 (10A)</td><td>10.000 / 5.0000</td></tr> <tr><td>CT9691 (100A)</td><td>100.00 / 10.000</td></tr> <tr><td>CT9692 (20A)</td><td>50.000* / 5.0000</td></tr> <tr><td>CT9692 (200A)</td><td>500.00* / 50.000</td></tr> <tr><td>CT9693 (200A)</td><td>500.00* / 50.000</td></tr> <tr><td>CT9693 (2kA)</td><td>5.0000k* / 500.00</td></tr> <tr><td>9657-10</td><td>5.0000 / 500.00m</td></tr> <tr><td>9675</td><td>5.0000 / 500.00m</td></tr> </tbody> </table> <p>*The full scale for each sensor is based on the specifications of the sensor in use, not the range setting on the PW3198.</p> <p>PW3198 Power ranges (automatically configured based on current range)</p> <table border="1"> <thead> <tr> <th>Current range</th> <th>Power range (W / VA / var)</th> </tr> </thead> <tbody> <tr><td>5.0000 kA</td><td>3.0000M</td></tr> <tr><td>1.0000 kA</td><td>600.00k</td></tr> <tr><td>500.00 A</td><td>300.00k</td></tr> <tr><td>100.00 A</td><td>60.000k</td></tr> </tbody> </table> <table border="1"> <thead> <tr> <th>Current range</th> <th>Power range (W / VA / var)</th> </tr> </thead> <tbody> <tr><td>50.000 A</td><td>30.000k</td></tr> <tr><td>10.000 A</td><td>6.0000k</td></tr> <tr><td>5.0000 A</td><td>3.0000k</td></tr> </tbody> </table>		Voltage measurement items	Ranges	Voltage measurement	600.00V	Transient measurement	6.0000kV peak	Current sensor	Current range setting (A)	9660	100.00 / 50.000	9661	500.00 / 50.000	9667 (500A) *Discontinued	500.00 / 50.000	9667 (5kA) *Discontinued	5.0000k / 500.00	CT9667 (500A)	500.00 / 50.000	CT9667 (5kA)	5.0000k / 500.00	9669	1.0000k / 100.00	9694	50.000 / 5.0000	9695-02	50.000 / 5.0000	9695-03	100.00 / 10.000	Current sensor	Current range setting(A)	CT9691 (10A)	10.000 / 5.0000	CT9691 (100A)	100.00 / 10.000	CT9692 (20A)	50.000* / 5.0000	CT9692 (200A)	500.00* / 50.000	CT9693 (200A)	500.00* / 50.000	CT9693 (2kA)	5.0000k* / 500.00	9657-10	5.0000 / 500.00m	9675	5.0000 / 500.00m	Current range	Power range (W / VA / var)	5.0000 kA	3.0000M	1.0000 kA	600.00k	500.00 A	300.00k	100.00 A	60.000k	Current range	Power range (W / VA / var)	50.000 A	30.000k	10.000 A	6.0000k	5.0000 A	3.0000k
Voltage measurement items	Ranges																																																																	
Voltage measurement	600.00V																																																																	
Transient measurement	6.0000kV peak																																																																	
Current sensor	Current range setting (A)																																																																	
9660	100.00 / 50.000																																																																	
9661	500.00 / 50.000																																																																	
9667 (500A) *Discontinued	500.00 / 50.000																																																																	
9667 (5kA) *Discontinued	5.0000k / 500.00																																																																	
CT9667 (500A)	500.00 / 50.000																																																																	
CT9667 (5kA)	5.0000k / 500.00																																																																	
9669	1.0000k / 100.00																																																																	
9694	50.000 / 5.0000																																																																	
9695-02	50.000 / 5.0000																																																																	
9695-03	100.00 / 10.000																																																																	
Current sensor	Current range setting(A)																																																																	
CT9691 (10A)	10.000 / 5.0000																																																																	
CT9691 (100A)	100.00 / 10.000																																																																	
CT9692 (20A)	50.000* / 5.0000																																																																	
CT9692 (200A)	500.00* / 50.000																																																																	
CT9693 (200A)	500.00* / 50.000																																																																	
CT9693 (2kA)	5.0000k* / 500.00																																																																	
9657-10	5.0000 / 500.00m																																																																	
9675	5.0000 / 500.00m																																																																	
Current range	Power range (W / VA / var)																																																																	
5.0000 kA	3.0000M																																																																	
1.0000 kA	600.00k																																																																	
500.00 A	300.00k																																																																	
100.00 A	60.000k																																																																	
Current range	Power range (W / VA / var)																																																																	
50.000 A	30.000k																																																																	
10.000 A	6.0000k																																																																	
5.0000 A	3.0000k																																																																	

**Basic specifications**

Maximum recording period	55 weeks (with repeated recording set to [1 Week], 55 iterations) 55 days (with repeated recording set to [1 Day], 55 iterations) 35 days (with repeated recording set to [OFF])
Maximum recordable events	55,000 events (with repeated recording on) 1000 events (with repeated recording off)
TIME PLOT data settings	TIME PLOT interval (MAX/MIN/AVG within each interval recorded) 1s, 3s, 15s, 30s, 1m, 5m, 10m, 15m, 30m, 1h, 2h, 150 cycle (at 50Hz), 180 cycle (at 60Hz), 1200 cycle (at 400Hz) Screen copy interval (screen shot at each interval saved to SD card) OFF, 5m, 10m, 30m, 1h, 2h Timer EVENT interval (200ms instantaneous waveform saved at each interval) OFF, 1m, 5m, 10m, 30m, 1h, 2h Time start and End OFF: Start recording manually ON: Start time and End time can be configured Repeated recording settings (maximum 55 iterations) OFF: Recording is not repeated 1Week: 55 weeks maximum in 1week segmentations 1Day: 55 days maximum in 1day segmentations Repeat time Daily Start time and End time can be configured when Repeated recording set to 1Day.
Recording items settings	Power (Small): Recording basic parameters P&Harm (Normal): Recording basic parameters and harmonics All Data (Full): Recording P&Harm items and inter-harmonics
Memory data capacity	Max. 32 GB with SD Card; only use of the HIOKI 2GB SD Memory Card Model Z4001 is guaranteed by HIOKI. Contact your HIOKI representative for special order larger capacity cards that offer the HIOKI guarantee.

PRESETS function	<b>U Events</b> : Record and monitor voltage elements and frequency, plus detect events <b>Standard Power Quality</b> : Record and monitor voltage and current elements, frequency, and harmonics, plus detect events <b>Inrush Current</b> : Measure inrush current (basic voltage measurement required) <b>Recording</b> : Record only trend data, no event detection <b>EN50160</b> : Measure according to EN50160 standards
Real-Time Clock function	Auto-calendar, leap-year correcting 24-hour clock
Display Language	English, Simplified Chinese, Japanese
Real-time clock accuracy	$\pm 0.3$ s per day (with instrument on, $23^{\circ}\text{C} \pm 5^{\circ}\text{C}$ ( $73^{\circ}\text{F} \pm 9^{\circ}\text{F}$ ))
Power supply	<b>AC ADAPTER Z1002</b> (12 VDC, Rated power supply 100VAC to 240VAC, 1.7Amax, 50/60Hz) <b>BATTERY PACK Z1003</b> (Ni-MH 7.2VDC 4500 mAh)
Maximum rated power	15VA (when not charging), 35VA (when charging)
Continuous battery operation time	Approx. 180 min. [ $@23^{\circ}\text{C}$ ( $@73.4^{\circ}\text{F}$ ), when using <b>BATTERY PACK Z1003</b> ]
Recharge function	<b>BATTERY PACK Z1003</b> charges regardless of whether the instrument is on or off; charge time: max. 5 hr. 30 min. $@23^{\circ}\text{C}$ ( $@73.4^{\circ}\text{F}$ )
Power outage processing	In the event of a power outage during recording, instrument resumes recording once the power is back on (integral power starts from 0).
Power supply quality measurement method	IEC61000-4-30 Ed.2 :2008 IEEE1159 EN50160 (using Model <b>PQA-HiVIEW PRO 9624-50</b> )
Dimensions	Approx. 300 W x 211 H x 68 D mm (11.81" W x 8.31" H x 2.68" D) (excluding protrusions)
Mass	Approx. 2.6 kg (91.7 oz.) (including battery pack)
Accessories	Instruction manual, Measurement guide, <b>VOLTAGE CORD L1000</b> (8 cords, approx. 3 m each: 1 each red, yellow, blue, and gray plus 4 black; 8 alligator clips: 1 each red, yellow, blue, and gray plus 4 black), Spiral Tube, Input Cable Labels (for identifying channel of voltage cords and clamp-on sensors), <b>AC ADAPTER Z1002</b> , Strap, USB cable (1 m length), <b>BATTERY PACK Z1003</b> , <b>SD MEMORY CARD (2GB) Z4001</b>

### Display specifications

Display	6.5-inch TFT color LCD (640 x 480 dots)
---------	---

### External Interface Specifications

SD card Interface	Saving of binary data, Saving and Loading setting files, Saving and Loading screen copies Slot : SD standard compliant Compatible card : SD memory card/ SDHC memory card Supported memory capacity : Max. 32 GB with SD Card; only use of the HIOKI 2GB SD Memory Card Model Z4001 is guaranteed by HIOKI. <i>Contact your HIOKI representative for special order larger capacity cards that offer the HIOKI guarantee.</i> Media full processing : Saving of data to SD memory card is stopped												
RS-232C Interface	Measurement and control using GPS-synchronized time (connecting GPS BOX) Connector : D-sub9pin Connection destination : GPS box (cannot be connected to computer)												
LAN Interface	1. HTTP server function (compatible software: Internet Explorer Ver.6 or later, Remote operation application function, measurement start and stop control functions, system configuration function, event list function (capable of displaying event waveforms, event vectors, and event harmonic bar graphs) 2. Downloading of data from the SD memory card using the 9624-50 PQA-HiView Pro Connector : RJ-45 Transmission method : 10BASE-T,100BASE-TX												
USB2.0 Interface	1. Recognizes the SD memory card as a removable disk when connected to a computer. <i>The instrument cannot be connected during recording (including standby operation) or analysis.</i> 2. Download data from the SD memory card using the 9624-50 PQA-HiView Pro <i>The instrument cannot be connected during recording (including standby operation) or analysis.</i> Connector : Series B receptacle Connection destination : Computer [WindowsXP, WindowsVista(32bit), Windows7 (32/64bit)]												
External control interface	Connector : 4-pin screwless terminal block External event input : External event input at TTL low level (at falling edge of 1.0 V or less and when shorted) between GND terminal and EVENT IN terminal Min. pulse width: 30 ms; rated voltage: -0.5 V to +6.0 V External event output : <table border="1" data-bbox="630 1310 1412 1478"> <thead> <tr> <th>External event output item setting</th> <th>Operation</th> <th>Pulse width</th> </tr> </thead> <tbody> <tr> <td>Short pulse output</td> <td>TTL low output at event generation between [GND] terminal and [EVENT OUT] terminal</td> <td>Low level for 10 ms or more</td> </tr> <tr> <td>Long pulse output</td> <td>TTL low output at event generation between [GND] terminal and [EVENT OUT] terminal (No external event output at START event)</td> <td>Low level for approx. 2.5 s</td> </tr> <tr> <td><math>\Delta V10</math> alarm</td> <td>TTL low output at <math>\Delta V10</math> alarm between [GND] terminal and [EVENT OUT] terminal</td> <td>Low level while alarm occurring ; reverts to high at data reset</td> </tr> </tbody> </table>	External event output item setting	Operation	Pulse width	Short pulse output	TTL low output at event generation between [GND] terminal and [EVENT OUT] terminal	Low level for 10 ms or more	Long pulse output	TTL low output at event generation between [GND] terminal and [EVENT OUT] terminal (No external event output at START event)	Low level for approx. 2.5 s	$\Delta V10$ alarm	TTL low output at $\Delta V10$ alarm between [GND] terminal and [EVENT OUT] terminal	Low level while alarm occurring ; reverts to high at data reset
External event output item setting	Operation	Pulse width											
Short pulse output	TTL low output at event generation between [GND] terminal and [EVENT OUT] terminal	Low level for 10 ms or more											
Long pulse output	TTL low output at event generation between [GND] terminal and [EVENT OUT] terminal (No external event output at START event)	Low level for approx. 2.5 s											
$\Delta V10$ alarm	TTL low output at $\Delta V10$ alarm between [GND] terminal and [EVENT OUT] terminal	Low level while alarm occurring ; reverts to high at data reset											

### Environment and safety specifications

Operating environment	Indoors, altitude up to 3000 m (measurement category is lowered to 600 V CAT III when above 2000m), Pollution degree 2
Storage temperature and humidity	-20 to $50^{\circ}\text{C}$ (-4 to $122^{\circ}\text{F}$ ) 80% RH or less (non-condensating) (If the instrument will not be used for an extended period of time, remove the battery pack and store in a cool location [from -20 to $30^{\circ}\text{C}$ (-4 to $86^{\circ}\text{F}$ ).])
Operating temperature and humidity	0 to $50^{\circ}\text{C}$ (32 to $122^{\circ}\text{F}$ ) 80% RH or less (non-condensating)
Dust and water resistance	IP30 (EN60529)
Maximum input voltage	Voltage input section 1000 VAC, DC $\pm 600$ V, max. peak voltage $\pm 6000$ Vpeak Current input section 3VAC, DC $\pm 4.24$ V
Maximum rated voltage to earth	Voltage input terminal 600 V (Measurement Categories IV, anticipated transient overvoltage 8000 V)
Dielectric strength	6.88 kVrms ( $@50/60$ Hz, 1 mA sense current): Between voltage measurement terminals (U1 to U3) and voltage measurement terminals (U4) 4.30 kVrms (1 mA $@50/60$ Hz, 1 mA sense current): Between voltage input terminal (U1 to U3) and current input terminals/interfaces Between voltage (U4) and current measurement terminals, and interfaces
Applicable standards	Safety EN61010 EMC EN61326 Class A, EN61000-3-2, EN61000-3-3



**Measurement Specifications** (For specifications when measuring 400Hz circuits, please inquire with your HIOKI distributor.)

**TIME PLOT** : The MAX/MIN/AVG of each recording interval for each parameter are recorded.

**EVENT** : When a power anomaly occurs, approx. 200ms instantaneous waveform is recorded.

**TRANSIENT** : When a transient overvoltage is detected, the 2ms instantaneous waveforms before and after the occurrence (total 4ms) are recorded.

**FLUCTUATION** : The RMS fluctuation 0.5s before and 29.5s after an event has occurred are recorded.

**HIGH-ORDER HARM** : When a high order harmonic event occurs, the 40ms instantaneous waveform is recorded.

### Transient overvoltage

**TRANSIENT**

**EVENT**

Display items	For single transient incidents and continuous transient incidents Transient voltage value, Transient width For continuous transient incidents Transient period (Period from transient IN to transient OUT) Max. transient voltage value (Max. peak value during the period) Transient count during period
Measurement method	Detected from waveform obtained by eliminating the fundamental component (50/60/400 Hz) from the sampled waveform
Sampling frequency	2MHz
Measurement range, resolution	±6.0000kVpeak, 0.0001kV
Measurement bandwidth	5 kHz (-3dB) to 700 kHz (-3dB)
Min. detection width	0.5 μs
Measurement accuracy	±5.0% rdg.±1.0%f.s.

### RMS voltage/ RMS current refreshed each half-cycle

**TIME PLOT**

**EVENT**

Measurement method	RMS voltage refreshed each half-cycle : True RMS type, RMS voltage values are calculated using sample data for 1 waveform derived by overlapping the voltage waveform every half-cycle RMS current refreshed each half-cycle : RMS current is calculated using current waveform data sampled every half-cycle
Sampling frequency	200kHz
Measurement range, resolution	RMS voltage refreshed each half-cycle : 600.00V, 0.01V RMS current refreshed each half-cycle : Based on clamp-on sensor in use; see Input specifications
Measurement accuracy	RMS voltage refreshed each half-cycle : ±0.2% of nominal voltage (With 1.666% f.s. to 110% f.s. input and a nominal input voltage of at least 100 V) ±0.2%rdg.±0.08%f.s. (With input outside the range of 1.666% f.s. to 110% f.s. or a nominal input voltage of less than 100 V) RMS current refreshed each half-cycle : ±0.3% rdg.±0.5%f.s. + clamp-on sensor accuracy

### Swell/ Dip/ Interruption

**FLUCTUATION**

**EVENT**

Display item	Swell : Swell height, Swell duration Dip : Dip depth, Dip duration Interruption : Interruption depth, Interruption duration
Measurement method	Swell : A swell is detected when the RMS voltage refreshed each half-cycle exceeds the threshold in the positive direction Dip : A dip is detected when the RMS voltage refreshed each half-cycle exceeds the threshold in the negative direction Interruption : An interruption is detected when the RMS voltage refreshed each half-cycle exceeds the threshold in the negative direction
Range and accuracy	See RMS voltage refreshed each half-cycle

### Inrush current

**FLUCTUATION**

**EVENT**

Display item	Maximum current of RMS current refreshed each 1/2 cycle
Measurement method	Detected when the RMS current refreshed each 1/2 cycle exceeds the threshold in a positive direction
Range and accuracy	See RMS current refreshed each half-cycle

### RMS voltage, RMS current

**TIME PLOT**

**EVENT**

Display items	RMS voltage : RMS voltage for each channel and AVG (average) RMS voltage for multiple channels RMS current : RMS current for each channel and AVG (average) RMS current for multiple channels
Measurement method	AC+DC True RMS type (Current DC value: with release of new clamp-on sensor) RMS value calculated from 10 cycles (50 Hz) or 12 cycles (60 Hz)
Sampling frequency	200kHz
Measurement range, resolution	RMS voltage : 600.00V, 0.01V RMS current : Based on clamp-on sensor in use; see Input specifications
Measurement accuracy	RMS voltage : ±0.1% of nominal voltage (With 1.666% f.s. to 110% f.s. input and a nominal input voltage of at least 100 V) ±0.2%rdg.±0.08%f.s. (With input outside the range of 1.666% f.s. to 110% f.s. or a nominal input voltage of less than 100 V) RMS current : ±0.2% rdg.±0.1%f.s. + clamp-on sensor accuracy

### Voltage waveform peak/ Current waveform peak

**TIME PLOT**

**EVENT**

Display item	Positive peak value and negative peak value
Measurement method	Measured every 10 cycles (50 Hz) or 12 cycles (60 Hz) maximum and minimum points sampled during approx. 200 ms aggregation
Sampling frequency	200kHz
Measurement range, resolution	Voltage waveform peak : ±1200.0 Vpeak, 0.1V Current waveform peak : The quadruple of RMS current measurement range (Based on clamp-on sensor in use; See Input specifications)

### Voltage waveform comparison

**EVENT**

Display item	Event detection only
Measurement method	A judgment area is automatically generated from the previous 200 ms aggregation waveform, and events are generated based on a comparison with the judgment waveform. Waveform judgments are performed once for each 200 ms aggregation.
Comparison window width	10 cycles (50 Hz), 12 cycles (60 Hz)
No. of window points	4096 points synchronized with harmonic calculations

### Frequency cycle

**TIME PLOT**

**EVENT**

Measurement method	Calculated as the reciprocal of the accumulated whole-cycle time during one U1 (reference channel) cycle
Measurement range, resolution	70.000Hz, 0.001Hz
Measurement bandwidth	40.000 to 70.000Hz
Measurement accuracy	±0.200 Hz or less (for input from 10% f.s. to 110% f.s.)

### Frequency

**TIME PLOT**

**EVENT**

Measurement method	Calculated as the reciprocal of the accumulated whole-cycle time during approx. 200ms period of 10 or 12 U1 (reference channel) cycles
Measurement range, resolution	70.000Hz, 0.001Hz
Measurement bandwidth	40.000 to 70.000Hz
Measurement accuracy	±0.020 Hz or less

### 10-sec frequency

**TIME PLOT**

Measurement method	Calculated as the reciprocal of the accumulated whole-cycle time during the specified 10s period for U1 (reference channel) as per IEC61000-4-30
Measurement range, resolution	70.000Hz, 0.001Hz
Measurement bandwidth	40.000 to 70.000Hz
Measurement accuracy	±0.010 Hz or less

**Voltage DC value (ch4 only)****TIME PLOT****EVENT**

Measurement method	Average value during approx. 20ms aggregation synchronized with the reference channel (CH4 only)
Sampling frequency	200kHz
Measurement range, resolution	600.00V, 0.01V
Measurement accuracy	±0.3%rdg. ±0.08%f.s.

**Current DC value (ch4 only; when using compatible sensor)****TIME PLOT****EVENT**

Measurement method	Average value during approx. 200ms aggregation synchronized to reference channel (CH4 only)
Sampling frequency	200kHz
Measurement range, resolution	Based on clamp-on sensor in use (with release of new clamp-on sensor)
Measurement accuracy	±0.5% rdg.±0.5%f.s. + clamp-on sensor accuracy

**Active power/ Apparent power/ Reactive power****TIME PLOT****EVENT**

Display items	Active power : Active power for each channel and sum value for multiple channels. Sink (consumption) and Source (regeneration) Apparent power : Apparent power of each channel and its sum for multiple channels No polarity Reactive power : Reactive power of each channel and its sum for multiple channels Lag phase (LAG: current lags voltage) and Lead phase (LEAD: current leads voltage)
Measurement method	Active power : Measured every 10 cycles (50 Hz) or 12 cycles (60 Hz) Apparent power : Calculated from RMS voltage U and RMS current I Reactive power : Calculated using apparent power S and active power P
Sampling frequency	200kHz
Measurement range, resolution	Depends on the voltage × current range combination; see Input specifications
Measurement accuracy	Active power : ±0.2% rdg.±0.1%f.s. + clamp-on sensor accuracy Apparent power : ±1 dgt. for calculations derived from the various measurement values Reactive power : ±1 dgt. for calculations derived from the various measurement values

**Active energy /Reactive energy****TIME PLOT**

Display items	Active energy : WP+ (consumption), WP- (regeneration); Sum of multiple channels Reactive energy : WQLAG (lag), WQLEAD (lead); Sum for multiple channels Elapsed time
Measurement method	Measured every 10 cycles (50 Hz) or 12 cycles (60 Hz) Integrated separately by consumption and regeneration from active power Integrated separately by lag and lead from reactive power Integration starts at the same time as recording Recorded at the specified TIMEPLOT interval
Sampling frequency	200kHz
Measurement range, resolution	Depends on the voltage × current range combination; see Input specifications
Measurement accuracy	Active energy : Active power measurement accuracy ±10 dgt. Reactive energy : Reactive power measurement accuracy ±10 dgt.

**Power factor /Displacement power factor****TIME PLOT****EVENT**

Display items	Displacement power factor of each channel and its sum value for multiple channels
Measurement method	Power factor : Calculated from RMS voltage U, RMS current I, and active power P Displacement power factor : Calculated from the phase difference between the fundamental voltage wave and the fundamental current wave Lag phase (LAG: current lags voltage) and Lead phase (LEAD: current leads voltage)
Sampling frequency	200kHz
Measurement range, resolution	-1.0000 (lead) to 0.0000 to 1.0000 (lag)

**Voltage unbalance factor/ Current unbalance factor (negative-phase, zero-phase)****TIME PLOT**

Display items	Voltage unbalance factor : Negative-phase unbalance factor, zero-phase unbalance factor Current unbalance factor : Negative-phase unbalance factor, zero-phase unbalance factor
Measurement method	Calculated using various components of the three-phase fundamental wave (line-to-line voltage) for three-phase 3-wire (3P3W2M, 3P3W3M) and three-phase 4-wire connections
Sampling frequency	200kHz
Measurement range	Voltage unbalance factor : Component is V and unbalance factor is 0.00% to 100.00% Current unbalance factor : Component is A and unbalance factor is 0.00% to 100.00%
Measurement accuracy	Voltage unbalance factor : ±0.15% Current unbalance factor : —

**High-order harmonic voltage component/ High-order harmonic current component****HIGH-ORDER HARM****TIME PLOT****EVENT**

Display items	For single incidents and continuous transient incidents High-order harmonic voltage component value High-order harmonic current component value For continuous incidents High-order harmonic voltage component maximum value High-order harmonic current component maximum value High-order harmonic voltage component period High-order harmonic current component period
Measurement method	The waveform obtained by eliminating the fundamental component is calculated using the true RMS method during 10 cycles (50 Hz) or 12 cycles (60 Hz) of the fundamental wave
Sampling frequency	200kHz
Measurement range, resolution	High-order harmonic voltage component : 600.00V, 0.01V High-order harmonic current component : Based on clamp-on sensor in use; See Input specifications
Measurement bandwidth	2kHz (-3dB) to 80kHz (-3dB)
Measurement accuracy	High-order harmonic voltage component : ±10%rdg. ±0.1%f.s. High-order harmonic current component : ±10% rdg.±0.2%f.s. + clamp-on sensor accuracy

**Harmonic voltage/ Harmonic current (including fundamental component)****TIME PLOT****EVENT**

Display items	Select either RMS or content percentage; From 0 to 50th order
Measurement method	Uses IEC61000-4-7:2002.
Comparison window width	10 cycles (50 Hz), 12 cycles (60 Hz)
No. of window points	4096 points synchronized with harmonic calculations
Measurement range, resolution	Harmonic voltage : 600.00V, 0.01V Harmonic current : Based on clamp-on sensor in use; see Input specifications
Measurement accuracy	See measurement accuracy with a fundamental wave of 50/60 Hz When using an AC-only clamp sensor, 0th order is not specified for current and power



**Total harmonic voltage/ Total harmonic current distortion factor****TIME PLOT****EVENT**

Display items	THD-F (total harmonic distortion factor for the fundamental wave) THD-R (total harmonic distortion factor for the total harmonic including the fundamental wave)
Measurement method	Based on IEC61000-4-7:2002; Max. order: 50th
Comparison window width	10 cycles (50 Hz), 12 cycles (60 Hz)
No. of window points	4096 points synchronized with harmonic calculations
Measurement range, resolution	0.00 to 100.00%(Voltage), 0.00 to 500.00%(Current)
Measurement accuracy	—

**Harmonic power (including fundamental component)****TIME PLOT****EVENT**

Display item	Select either RMS or content percentage; From 0 to 50th order
Measurement method	Uses IEC61000-4-7:2002.
Comparison window width	10 cycles (50 Hz), 12 cycles (60 Hz)
No. of window points	4096 points synchronized with harmonic calculations
Measurement range, resolution	Depends on the voltage × current range combination; See Input specifications
Measurement accuracy	See measurement accuracy with a fundamental wave of 50/60 Hz (When using an AC-only clamp sensor, order 0 is not specified for current and power)

Measurement accuracy with a fundamental wave of 50/60 Hz

Harmonic input	Measurement accuracy
Voltage (At least 1% of nominal voltage)	Specified with a nominal voltage of at least 100 V Order 0: ±0.3%rdg.±0.08%f.s. Order 1+: ±5.00%rdg
Voltage (<1% of nominal voltage)	Specified with a nominal voltage of at least 100 V Order 0: ±0.3%rdg.±0.08%f.s. Order 1+: ±0.05% of nominal voltage
Current	Order 0: ±0.5%rdg.±0.5%f.s. +clamp-on sensor accuracy Order 1 to 20th: ±0.5%rdg.±0.2%f.s. +clamp-on sensor accuracy Order 21 to 50th: ±1.0%rdg.±0.3%f.s. +clamp-on sensor accuracy
Power	Order 0: ±0.5%rdg.±0.5%f.s. +clamp-on sensor accuracy Order 1 to 20th: ±0.5%rdg.±0.2%f.s. +clamp-on sensor accuracy Order 21 to 30th: ±1.0%rdg.±0.3%f.s. +clamp-on sensor accuracy Order 31 to 40th: ±2.0%rdg.±0.3%f.s. +clamp-on sensor accuracy Order 41 to 50th: ±3.0%rdg.±0.3%f.s. +clamp-on sensor accuracy

**Harmonic voltage phase angle/ Harmonic current phase angle (including fundamental component)****TIME PLOT**

Display item	Harmonic phase angle components for whole orders
Measurement method	Uses IEC61000-4-7:2002.
Comparison window width	10 cycles (50 Hz), 12 cycles (60 Hz)
No. of window points	4096 points synchronized with harmonic calculations
Measurement range, resolution	-180.00° to 0.00° to 180.00°
Measurement accuracy	—

**Harmonic voltage-current phase angle (including fundamental component)****TIME PLOT****EVENT**

Display item	Indicates the difference between the harmonic voltage phase angle and the harmonic current phase angle. Harmonic voltage-current phase difference for each channel and sum (total) value for multiple channels
Measurement method	Uses IEC61000-4-7:2002.
Comparison window width	10 cycles (50 Hz), 12 cycles (60 Hz)
No. of window points	4096 points synchronized with harmonic calculations
Measurement range, resolution	-180.00° to 0.00° to 180.00°
Measurement accuracy	1st to 3rd orders : ± 2° +clamp-on sensor accuracy 4th to 50th orders : ±(0.05° × k+2°) +clamp-on sensor accuracy; (k: harmonic orders) Specified with a harmonic voltage of 1 V for each order and a current level of at 1% f.s. or greater.

**Inter-harmonic voltage and inter-harmonic current****TIME PLOT**

Display item	Select either RMS or content percentage; 0.5 to 49.5th orders
Measurement method	Uses IEC61000-4-7:2002.
Comparison window width	10 cycles (50 Hz), 12 cycles (60 Hz)
No. of window points	4096 points synchronized with harmonic calculations
Measurement range, resolution	Inter-harmonic voltage : 600.00V, 0.01V Inter-harmonic current : Due to using clamp-on sensor; See Input specifications
Measurement accuracy	Inter-harmonic voltage (Specified with a nominal voltage of at least 100 V) : At least 1% of harmonic input nominal voltage: ±5.00% rdg. <1% of harmonic input nominal voltage : ±0.05% of nominal voltage Inter-harmonic current : Unspecified

**K Factor (multiplication factor)****TIME PLOT****EVENT**

Measurement method	Calculated using the harmonic RMS current of the 2nd to 50th orders
Comparison window width	10 cycles (50 Hz), 12 cycles (60 Hz)
No. of window points	4096 points synchronized with harmonic calculations
Measurement range, resolution	0.00 to 500.00
Measurement accuracy	—

**Instantaneous flicker value****TIME PLOT**

Measurement method	As per IEC61000-4-15 User-selectable from 230 Vlamp/120 Vlamp (when Pst and PIt are selected for flicker measurement)/4 types of Ed2 filter (230 Vlamp 50/60 Hz, 120 Vlamp 60/50 Hz)
Measurement range, resolution	99.999, 0.001

**Δ V10 Flicker****TIME PLOT**

Display items	ΔV10 measured at one minute intervals, average value for one hour, maximum value for one hour, fourth largest value for one hour, total (within the measurement interval) maximum value
Measurement method	Calculated values are subject to 100 V conversion following gap-less measurement once each minute
Measurement range, resolution	0.000 to 99.999V
Measurement accuracy	±2% rdg.±0.01 V (with a fundamental wave of 100 Vrms [50/60 Hz], a fluctuation voltage of 1 Vrms, and a fluctuation frequency of 10 Hz)
Threshold	0.00 to 9.99V alarm output is generated when the reading for each minute is compared to the threshold and found to be greater



**IEC Flicker****TIME PLOT**

Display items	Short interval flicker Pst, long interval flicker PIt
Measurement method	Based on IEC61000-4-15:1997 +A1:2003 Ed1/Ed2. Pst is calculated after 10 minutes of continuous measurement and PIt after 2 hours of continuous measurement
Measurement range	0.0001 to 10000 P.U. broken into 1,024 segments with a logarithm
Measurement accuracy	Pst ±5% rdg. (Specified within range 0.1000 to 20.000 using IEC61000-4-15 Ed1.1 and IEC61000-4-15 Ed2 Class F1 performance test.)
Flicker filter	Select 230 V lamp Ed1, 120 V lamp Ed1, 230 V lamp Ed2, or 120 V lamp Ed2.



## Clamp-on sensors specifications (Options)

Clamp-on sensor	CLAMP ON SENSOR 9694	CLAMP ON SENSOR 9660	CLAMP ON SENSOR 9661
Appearance			
Primary current rating	5A AC	100A AC	500A AC
Output voltage	10mV/A AC	AC 1mV/A AC	AC 1mV/A AC
Measurement range	See input specifications		
Amplitude accuracy *	$\pm 0.3\% \text{rdg.} \pm 0.02\% \text{f.s.}^*$	$\pm 0.3\% \text{rdg.} \pm 0.02\% \text{f.s.}^*$	$\pm 0.3\% \text{rdg.} \pm 0.01\% \text{f.s.}^*$
Phase accuracy *	$\pm 2^\circ$ or less *	$\pm 1^\circ$ or less *	$\pm 0.5^\circ$ or less *
Maximum allowable input *	50 A continuous *	130 A continuous *	550 A continuous *
Maximum rated voltage to earth	CAT III 300Vrms		CAT III 600 Vrms
Frequency characteristics	$\pm 1.0\%$ or less for 66Hz to 5kHz (deviation from specified accuracy)		
Cord length	3m (9.84ft)		
Measurable conductor diameter	Max. $\phi 15\text{mm}$ (0.59")		Max. $\phi 46\text{mm}$ (1.81")
Dimensions, Mass	46W(1.81") $\times$ 135H(5.31") $\times$ 21D(0.83")mm, 230g(8.1oz.)		78W(3.07") $\times$ 152H(5.98") $\times$ 42D(1.65")mm, 380g(13.4oz.)

\*: 45 to 66Hz

Clamp-on sensor	CLAMP ON SENSOR 9669	FLEXIBLE CLAMP ON SENSOR CT9667
Appearance		
Primary current rating	1000 A AC	500A AC, 5000A AC
Output voltage	0.5mV/A AC	500 mV AC f.s.
Measurement range	See input specifications	
Amplitude accuracy *	$\pm 1.0\% \text{rdg.} \pm 0.01\% \text{f.s.}^*$	$\pm 2.0\% \text{rdg.} \pm 0.3\% \text{f.s.}^*$
Phase accuracy *	$\pm 1^\circ$ or less *	$\pm 1^\circ$ or less *
Maximum allowable input *	1000 A continuous *	10000 A continuous *
Maximum rated voltage to earth	CATIII 600Vrms	CATIII 1000 Vrms CATIV 600 Vrms
Frequency characteristics	Within $\pm 2\%$ at 40Hz to 5kHz (deviation from accuracy)	$\pm 3\text{dB}$ or less for 10 Hz to 20kHz (within $\pm 3\text{dB}$ )
Cord length	3m (9.84ft)	Sensor to circuit: 2m (6.56ft) Circuit to connector: 1m (3.28ft)
Measurable conductor diameter	Max. $\phi 55\text{ mm}$ (2.17"), 80 (3.15") $\times$ 20(0.79") mm busbar	Max. $\phi 254\text{mm}$ (10")
Dimensions, Mass	99.5W (3.92") $\times$ 188H (7.40") $\times$ 42D (1.65") mm, 590g (20.8 oz.)	Circuit box: 35W (1.38") $\times$ 120.5H (4.74") $\times$ 34D (1.34") mm, 140 g (4.9 oz.)
Power supply	—	LR6 alkaline battery x2, AC Adapter (option) or external 5 to 15 V DC power supply
Options (sold separately)		AC ADAPTER 9445-02 (universal 100 to 240VAC, 9V/1A output/for USA) AC ADAPTER 9445-03 (universal 100 to 240VAC, 9V/1A output/for Europe)

\*: 45 to 66Hz

Clamp-on sensor	CLAMP ON SENSOR 9695-02	CLAMP ON SENSOR 9695-03
Appearance		
Primary current rating	50A AC	100A AC
Output voltage	10mV/A AC	1mV/A AC
Measurement range	See input specifications	
Amplitude accuracy *	$\pm 0.3\% \text{rdg.} \pm 0.02\% \text{f.s.}^*$	$\pm 0.3\% \text{rdg.} \pm 0.02\% \text{f.s.}^*$
Phase accuracy *	Within $\pm 2^\circ$ *	Within $\pm 1^\circ$ *
Maximum allowable input *	130 A continuous *	130 A continuous *
Maximum rated voltage to earth	CATIII 300Vrms (insulated conductor)	
Frequency characteristic	Within $\pm 2\%$ at 40Hz to 5kHz (deviation from accuracy)	
Cord length	CONNECTION CORD 9219 (sold separately) is required.	
Measurable conductor diameter	Max. $\phi 15\text{mm}$ (0.59")	
Dimensions, Mass	51W(2.01") $\times$ 58H(2.28") $\times$ 19D(0.75")mm, 50g(1.8oz.)	
Options (sold separately)	CONNECTION CORD 9219 (Cord length:3m (9.84ft))	







Note: CONNECTION CORD 9219 (sold separately) is required.

\*: 45 to 66Hz





CONNECTION CORD 9219



Clamp-on AC/DC sensor	AC/DC CLAMP ON SENSOR CT9691-90 (CT9691 bundled with the CT6590)	AC/DC CLAMP ON SENSOR CT9692-90 (CT9692 bundled with the CT6590)	AC/DC CLAMP ON SENSOR CT9693-90 (CT9693 bundled with the CT6590)
Appearance			
Includes	CT9691 x1, CT6590 x1	CT9692 x1, CT6590 x1	CT9693 x1, CT6590 x1
<b>CT9691,CT9692,CT9693 (Clamp sensor) specifications</b>			
	<b>CT9691</b> 	<b>CT9692</b> 	<b>CT9693</b> 
Primary current rating	100A AC/DC	200A AC/DC	2000A AC/DC
Maximum input range (RMS value)	100Arms continuous*	200Arms continuous*	2000Arms continuous*
Maximum rated voltage to earth	CAT III AC/DC 600V		
Frequency band	DC to 10 kHz (-3dB)	DC to 20 kHz (-3dB)	DC to 15 kHz (-3dB)
Cord length	2m (6.5 ft)		
Measurable conductor diameter	35 mm (1.38") or less	33 mm (1.30") or less	55 mm (2.17") or less
Dimensions, Mass	53W(2.09") x 129H(5.08") x 18D(0.71") mm, 230g (8.1 oz.)	62W(2.44") x 167H(6.57") x 35D(1.38") mm, 410g (14.5 oz.)	62W(2.44") x 196H( 7.72") x 35D(1.38") mm, 500g (17.6 oz.)
<b>CT6590 (SENSOR UNIT) specifications</b>			
	<b>CT6590</b> 		
Range when combined with sensor (H/L selectable)	H range : 100A AC/DC f.s. L range : 10A AC/DC f.s.	H range : 200A AC/DC f.s. L range : 20A AC/DC f.s.	H range : 2000A AC/DC f.s. L range : 200A AC/DC f.s.
Sensor combination Output rate	H range : 1mV/A L range : 10mV/A	H range : 1mV/A L range : 10mV/A	H range : 0.1mV/A L range : 1mV/A
Sensor combination measurement range	See input specifications		
Sensor combination accuracy (Continuous input)	±1.5%rdg.±1.0%f.s. (DC ≤ f ≤ 66 Hz)	±1.5%rdg.±0.5%f.s. (DC ≤ f ≤ 66 Hz)	±2.0%rdg.±0.5%f.s. (DC) ±1.5%rdg.±0.5%f.s. (45 ≤ f ≤ 66Hz, I ≤ 1800A) ±2.5%rdg.±0.5%f.s. (45 ≤ f ≤ 66Hz, 1800A < I ≤ 2000A)
Sensor combination accuracy (Phase)	±2deg. (DC < f ≤ 66 Hz)	±2deg. (DC < f ≤ 66 Hz)	±2deg. (45Hz ≤ f ≤ 66 Hz)
Cord length	1m (3.3ft)		
Dimensions, Mass	36W(1.42") x 120H(4.72") x 34D(1.34") mm (excluding protruding parts), 165g(5.8 oz.) (including batteries)		
Power supply	LR6 alkaline battery x2, optional AC adapter, or 5 V to 15 VDC external power		
Options (sold separately)	AC ADAPTER 9445-02 (universal 100 to 240VAC , 9V/1A output/for USA) AC ADAPTER 9445-03 (universal 100 to 240VAC , 9V/1A output/for Europe)		

\* : Derating according to frequency

Clamp-on leak sensor	CLAMP ON LEAK SENSOR 9657-10	CLAMP ON LEAK SENSOR 9675
Appearance		
Primary current rating	10A AC (Up to 5A on Model PW3198)	
Output voltage	100 mV/A AC	
Measurement range	See input specifications (Cannot be used to measure power)	
Amplitude accuracy *	±1.0%rdg.±0.05%f.s. *	±1.0%rdg.±0.005%f.s. *
Residual current characteristics	Max. 5mA (in 100A go and return electric wire)	Max. 1mA (in 10A go and return electric wire)
Effect of external magnetic fields	400A AC/m corresponds to 5mA, Max. 7.5mA	
Maximum rated voltage to earth	CATIII 300Vrms (insulated conductor)	
Cord length	3m (9.84ft)	
Measurable conductor diameter	Max. φ40 mm(1.57")	Max. φ30 mm(1.18oz")
Dimensions, Mass	74W(2.91")x145H(5.71")x 42D(1.65)mm, 380g(13.4oz.)	60W(2.36")x112.5H(4.43")x 23.6D(23.6")mm, 160g(5.6oz.)

\* : 45 to 66Hz

Current measurement (see P.14 -15 Clamp-on sensors specifications for details)

<p><b>CLAMP ON SENSOR (Load current, AC)</b></p> <p><b>9694</b> 5A AC, <math>\phi</math>15mm(0.59")</p> <p><b>9661</b> 500A AC, <math>\phi</math>46mm(1.81")</p> <p><b>CT9667</b> 500A AC / 5000A AC (selectable), <math>\phi</math>254mm (10") Power supply: LR06 alkaline battery or <b>AC ADAPTER 9445-02/03</b> (sold separately)</p> <p><b>9660</b> 100A AC, <math>\phi</math>15mm(0.59")</p> <p><b>9669</b> 1000A AC, <math>\phi</math>55mm(2.17"), 80(3.15")<math>\times</math>20(0.79")mm busbar</p>			<p><b>CLAMP ON AC/DC SENSOR (Load current, AC/DC)</b></p> <p><b>CT9691-90</b> 100A ACDC / 10A ACDC (selectable), <math>\phi</math>35mm(1.38") Power supply: LR6 alkaline battery or <b>AC ADAPTER 9445-02/03</b> (sold separately)</p> <p><b>CT9692-90</b> 200A ACDC / 20A ACDC (selectable), <math>\phi</math>33mm(1.30") Power supply: LR6 alkaline battery or <b>AC ADAPTER 9445-02/03</b> (sold separately)</p> <p><b>CT9693-90</b> 2000A ACDC / 200A ACDC (selectable), <math>\phi</math>55mm(2.17") Power supply: LR6 alkaline battery or <b>AC ADAPTER 9445-02/03</b> (sold separately)</p> <p>The CT9691-90, CT9692-90, and CT9693-90 represent the respective clamp sensor bundled with the CT6590 Sensor Unit.</p>		
<p><b>CLAMP ON ADAPTER</b></p> <p><b>9695-02</b> (50A AC) <b>9695-03</b> (100A AC) <math>\phi</math>15mm(0.59"), <b>CONNECTION CORD 9219</b> is required (sold separately)</p>		<p><b>CLAMP ON LEAK SENSOR (Leak Current)</b> Cannot be used to measure power</p> <p><b>9675</b> 10A AC(Up to 5A on Model PW3198), <math>\phi</math>30mm(1.18")</p>		<p><b>CONNECTION CORD 9219</b> For connecting 9695-02,9695-03 Cord length : 3m(9.84ft)</p>	<p><b>9290-10</b> CT ratio 10:1, AC1000A, <math>\phi</math>55mm(2.17"), 80(3.15")<math>\times</math>20(0.79")mm busbar, Cord length : 3m(9.84ft)</p>

Voltage measurement

<p><b>WIRING ADAPTER PW9000</b> For 3P3W WIRING</p>	<p><b>WIRING ADAPTER PW9001</b> For 3P4W WIRING</p>	<p><b>MAGNETIC ADAPTER 9804-01</b> (red) <b>MAGNETIC ADAPTER 9804-02</b> (black) Magnetic tip for use with the standard Voltage Cord <b>L1000</b> (generally compatible with M6 pan screws)</p> <p>Red and black adapters sold separately. Purchase the quantity and color appropriate for your application. (Example: 3P3W - 3 adapters; 3P4W - 4 adapters)</p>	<p><b>GRABBER CLIP 9243</b> For use with the standard Voltage Cord <b>L1000</b></p>
---	---	--	---

Reduce voltage cords for easy wiring

Application software

**PQA-HiVIEW PRO 9624-50**  
Use Model 9624-50 PQA-HiVIEW PRO (version 2.00 or later) with a PC to analyze the data collected by the PW3198.

Case

<p><b>CARRYING CASE C1001</b> Soft case 450W<math>\times</math>345W<math>\times</math>210Dmm (17.7"W<math>\times</math>13.6"H<math>\times</math>8.3"D) 3.4kg (120oz.)</p>	<p><b>CARRYING CASE C1002</b> Hard case 413W<math>\times</math>595W<math>\times</math>265Dmm (16.3"W<math>\times</math>23.4"H<math>\times</math>10.4"D) 5.7kg (201oz.)</p>
---	--

**POWER QUALITY ANALYZER PW3198-90**  
(Set with PQA HiVIEW PRO 9624-50 and bundled accessories)

**IMPORTANT**  
Use Model PQA-HiVIEW PRO 9624-50 (version 2.00 or later) with a PC to analyze the data collected by the PW3198.

**POWER QUALITY ANALYZER PW3198**  
(Bundled accessories)  
**SD MEMORY CARD 2GB Z4001**,  
**VOLTAGE CORD L1000**, **AC ADAPTER Z1002**,  
**BATTERY PACK Z1003**, Instruction manual  
Measurement guide, Strap, USB cable (Approx. 1m in length)

Bundled accessories

<p><b>Voltage Cord L1000</b> 8 cords, approx. 3 m each: 1 each red, yellow, blue, and gray plus 4 black; 8 alligator clips: 1 each red, yellow, blue, and gray plus 4 black</p>	<p><b>AC ADAPTER Z1002</b> Power supply for the PW3198 100V AC to 240V AC</p>
<p><b>SD MEMORY CARD 2GB Z4001</b></p> <p><b>IMPORTANT</b> Use only the SD Card Z4001 sold by HIOKI.</p>	<p><b>BATTERY PACK Z1003</b> (Ni-MH, 7.2 V/4500 mAh)</p>

Clock synchronization

**GPS BOX PW9005**  
To synchronize the PW3198 clock,  
Accessory: Connection cable set

●Combination example: For three-phase 4-wire circuits containing leak current

<b>PW3198-90</b>	+	<b>9661 <math>\times</math> 3</b>	+	<b>9675</b>	+	<b>PW9001</b>	+	<b>C1001</b>
POWER QUALITY ANALYZER PW3198 set with PQA HiVIEW PRO 9624-50		CLAMP ON SENSOR (500A)		CLAMP ON LEAK SENSOR		WIRING ADAPTER		CARRYING CASE

Note: Company names and Product names appearing in this catalog are trademarks or registered trademarks of various companies.



HIOKI E. E. CORPORATION

HEADQUARTERS:

81 Koizumi, Ueda, Nagano, 386-1192, Japan  
TEL +81-268-28-0562 FAX +81-268-28-0568  
http://www.hioki.com / E-mail: os-com@hioki.co.jp

HIOKI USA CORPORATION:

TEL +1-609-409-9109 FAX +1-609-409-9108  
http://www.hiokiusa.com / E-mail: hioki@hiokiusa.com

**HIOKI (Shanghai) SALES & TRADING CO., LTD.:**  
TEL +86-21-63910090 FAX +86-21-63910360  
http://www.hioki.cn / E-mail: info@hioki.com.cn

**HIOKI INDIA PRIVATE LIMITED:**  
TEL +91-731-6548081 FAX +91-731-4020083  
E-mail: info@hioki.in

**HIOKI SINGAPORE PTE. LTD.:**  
TEL +65-6634-7677 FAX +65-6634-7477  
E-mail: info@hioki.com.sg

**HIOKI KOREA CO., LTD.:**  
TEL +82-42-936-1281 FAX +82-42-936-1284  
E-mail: info-kr@hioki.co.jp

DISTRIBUTED BY